



CO  
CO

ARKOSLIGHT



# Kompakt und Leistungsstark

LED der neuen Generation. **154lm/W**  
Lichteffizienz. Ein kompakter Aluminiumzylinder  
mit einem Lichtstrom von **1340 lm**.



# Bewegungsfreiheit

360° Drehung und 90° Neigung.



COCO



20°



34°



48°

COCO 48V TUNABLE WHITE



28°



42°



54°

# Beleuchtungsfreiheit

Drei Öffnungswinkel **spot** / **medium** / **flood** + **Super spot Version 12°**.

Deckt verschiedene Bedürfnisse ab: Akzentbeleuchtung, allgemeine Beleuchtung...



# Coco Super Spot

Hochtechnisch (**Beam 12°**). Sorgfältig ausgewählte LED und Linsen von hoher Qualität. Bietet einen gleichmäßigen Lichtstrom und angenehme Blendungsniveaus.

# DIM on board Option

Perfekte Integration für 48V-Systeme.  
Ermöglicht eine unabhängige Regelung der  
Intensität jeder Leuchte von **0** bis **100**.



# Zubehör

Verschiedene Zubehörteile erhältlich:  
**Anti-Glare-Honeycomb** und **Anti-Glare-Screen**,  
die die Blendung reduzieren und den  
visuellen Komfort fördern.



COCO ANTI-GLARE SCREEN



COCO ANTI-GLARE  
HONEYCOMB LOUVER

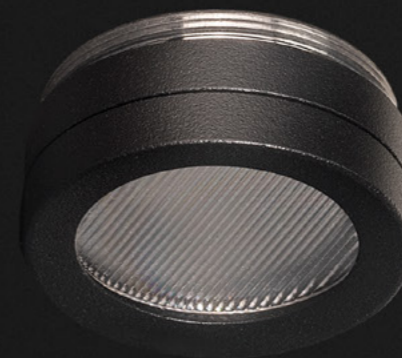



# Linear Filter

Verwandelt den kreisförmigen Lichtstrahl in eine **lineare Form**. Ideal für Anwendungen, bei denen eine präzise und lineare Lichtverteilung benötigt wird.





**MAGNETIC 24V COCO**



8:20h · 3700K



12:00h · 5000K



17:00h · 2700K

# Tunable white

Verfügbar für Coco 48V. Sehr geschätzt in Wohn-, Gastgewerbe-, Büro-Umgebungen, etc.



**COCO**  
TECHNISCHE  
SPEZIFIKATIONEN



# MAGNETIC 24V COCO

## OPTIONAL ACCESSORIES

### COCO Anti-glare Honeycomb Louver\*\*

A498-90-00- | WT | NT |



### COCO Linear Filter\*\*

A498-90-02- | WT | NT |

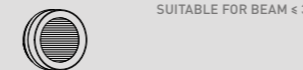

### COCO Anti-glare Screen\*\*

A498-90-01- | WT | NT |



### COCO High Chromatic Led\*\* ⓘ » 281

NOT SOLD SEPARATELY

### TRIMLESS TOOL D16 X D34mm

A478-00-00

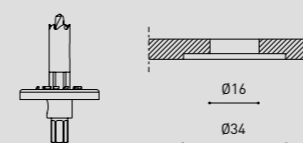

		P	CCT	Beam	I	Flux	LOR
<b>MAGNETIC 24V COCO</b>	A499-00-10-   WT   NT	8,7W	2700K	20°	500mA	1200 lm	87%
	A499-00-11-   WT   NT	8,7W	3000K	20°	500mA	1250 lm	87%
	A499-00-12-   WT   NT	8,7W	4000K	20°	500mA	1340 lm	87%
	A499-00-20-   WT   NT	8,7W	2700K	34°	500mA	1200 lm	89%
	A499-00-21-   WT   NT	8,7W	3000K	34°	500mA	1250 lm	89%
	A499-00-22-   WT   NT	8,7W	4000K	34°	500mA	1340 lm	89%
	A499-00-30-   WT   NT	8,7W	2700K	48°	500mA	1200 lm	86%
	A499-00-31-   WT   NT	8,7W	3000K	48°	500mA	1250 lm	86%
	A499-00-32-   WT   NT	8,7W	4000K	48°	500mA	1340 lm	86%

24 V | ⓘ IP20 | CRI>90 | L80B10 > 66.000h



		P	CCT	Beam	I	Flux	LOR
<b>MAGNETIC 24V COCO Super Spot</b>	A499-00-00-   WT   NT	6W	2700K	12°	500mA	750 lm	66%
	A499-00-01-   WT   NT	6W	3000K	12°	500mA	800 lm	66%
	A499-00-02-   WT   NT	6W	4000K	12°	500mA	850 lm	66%

24 V | ⓘ IP20 | CRI>90 | L80B10 > 55.000h



## MAGNETIC 24V CONNECTOR A435-01-00 | W | N |

\* MANDATORY FOR INSTALLATION

ⓘ IP20 | ⓘ Ø16

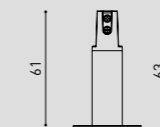
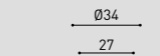

INCLUDED EXTRA COVER FOR RECESSED VERSION

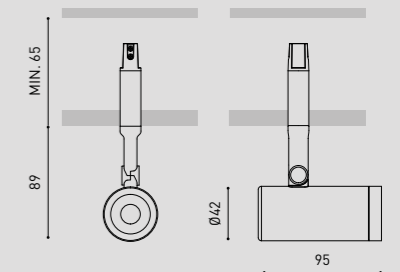

	P	V	D (A x B x C)
<b>24V POWER SUPPLY</b>			
0434-01-37	60W	24V	180 x 52 x 30mm
0433-10-22	100W	24V	295 x 43 x 30mm

220-240 V~ | MUST BE PLACED ON REMOTE

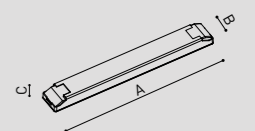

		V	D (A x B x C)
<b>24V DIMMER</b>			
0433-01-32	DALI / Push	24V	181 x 42 x 20mm
0433-01-33	CASAMBI	24V	172 x 42 x 20mm
0434-01-64	WIFI	24V	105 x 44 x 23mm

24 V | MUST BE PLACED ON REMOTE  
OTHER DIM OPTIONS PLEASE CONSULT

ⓘ DROP VOLTAGE » 287

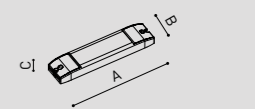

COLOUR | WT □ | NT ■ | MATERIAL | AL | PC/PMMA |

PLEASE CONSULT » ⓘ

OTHER CCT OPTIONS PLEASE CONSULT  
\*\* AFFECTS THE LIGHTING PARAMETERS



# COCO 48V

## OPTIONAL ACCESSORIES

AFFECT THE LIGHTING PARAMETERS

### COCO Anti-glare Honeycomb Louver

A498-90-00- | WT | NT |



### COCO Anti-glare Screen

A498-90-01- | WT | NT |



### COCO Linear Filter

A498-90-02- | WT | NT |

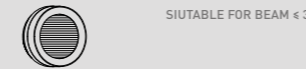

### COCO High Chromatic Led

NOT SOLD SEPARATELY

## FINISHING

FINISHING	Lamp	Adaptor
WT	WT □   N ■	
NT	NT ■   N ■	
WTW	WT □   W □	
NTW	NT ■   W □	

COCO 48V	+RE	P	CCT	Beam	I	Flux	LOR
A498-0- ① -10-   WT   NT   WTW   NTW   -S		8,7W	2700K	20°	500mA	1200 lm	87%
A498-0- ① -11-   WT   NT   WTW   NTW   -S		8,7W	3000K	20°	500mA	1250 lm	87%
A498-0- ① -12-   WT   NT   WTW   NTW   -S		8,7W	4000K	20°	500mA	1340 lm	87%
A498-0- ① -20-   WT   NT   WTW   NTW   -S		8,7W	2700K	34°	500mA	1200 lm	89%
A498-0- ① -21-   WT   NT   WTW   NTW   -S		8,7W	3000K	34°	500mA	1250 lm	89%
A498-0- ① -22-   WT   NT   WTW   NTW   -S		8,7W	4000K	34°	500mA	1340 lm	89%
A498-0- ① -30-   WT   NT   WTW   NTW   -S		8,7W	2700K	48°	500mA	1200 lm	86%
A498-0- ① -31-   WT   NT   WTW   NTW   -S		8,7W	3000K	48°	500mA	1250 lm	86%
A498-0- ① -32-   WT   NT   WTW   NTW   -S		8,7W	4000K	48°	500mA	1340 lm	86%

48 V | IP20 | CRI>90 | L80B10 >66.000h



## COCO 48V Super Spot

COCO 48V Super Spot	+RE	P	CCT	Beam	I	Flux	LOR
A498-0- ① -00-   WT   NT   WTW   NTW   -S		6W	2700K	12°	500mA	750 lm	66%
A498-0- ① -01-   WT   NT   WTW   NTW   -S		6W	3000K	12°	500mA	800 lm	66%
A498-0- ① -02-   WT   NT   WTW   NTW   -S		6W	4000K	12°	500mA	850 lm	66%

48 V | IP20 | CRI>90 | L80B10 >55.000h

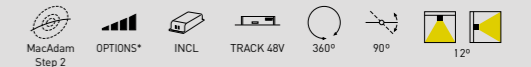

## COCO 48V Tunable White

COCO 48V Tunable White	+RE	P	CCT	Beam	I	Flux	LOR
A498-12-18-   WT   NT   WTW   NTW   -S		8,5W	2700-5000K	28°	500mA	1010 lm	85%
A498-12-28-   WT   NT   WTW   NTW   -S		8,5W	2700-5000K	42°	500mA	1010 lm	87%
A498-12-38-   WT   NT   WTW   NTW   -S		8,5W	2700-5000K	54°	500mA	1010 lm	84%

48 V | IP20 | CRI>90 | L80B10 >55.000h



## \*OPTIONS

1	No DIM
2	DIM DALI
7	DIM ON BOARD

OTHER DIM OPTIONS PLEASE CONSULT

+RE	REF. ENDING	EXAMPLE
0	Track 48V	A4980110WT
-S	Track 48V Short	A4980110WT-S

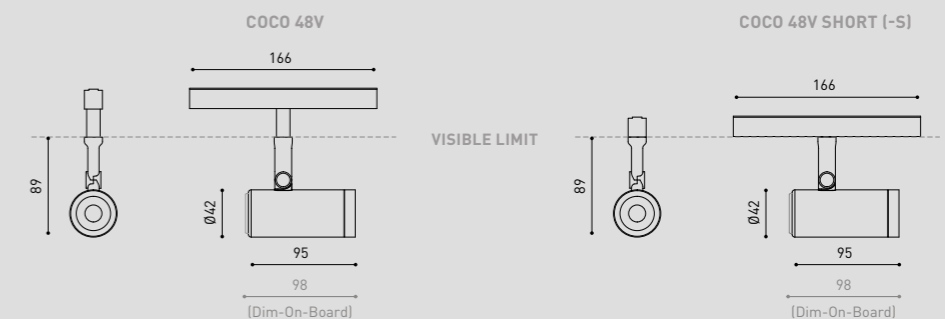

COLOUR | WT □ | NT ■ | MATERIAL | AL | PC/PMMA |

PLEASE CONSULT »

OTHER CCT PLEASE CONSULT

+RE >> THE PRODUCTS FOR THE TRACK 48V SHORT, ADD "-S" AT THE END OF THE SALES REFERENCE (AFTER THE LETTERS WHICH INDICATE THE COLOUR OF THE PRODUCT).

# OPTIONAL ACCESSORIES



COCO



COCO SUPER SPOT



COCO ANTI-GLARE HONEYCOMB LOUVER



COCO LINEAR FILTER



COCO ANTI-GLARE SCREEN

# FINISHINGS



NT



WT



NTW



WTW



NT



WT



NT SUPER SPOT



WT SUPER SPOT

CO  
CO

by ARKOSLIGHT